

Downtown Harlem

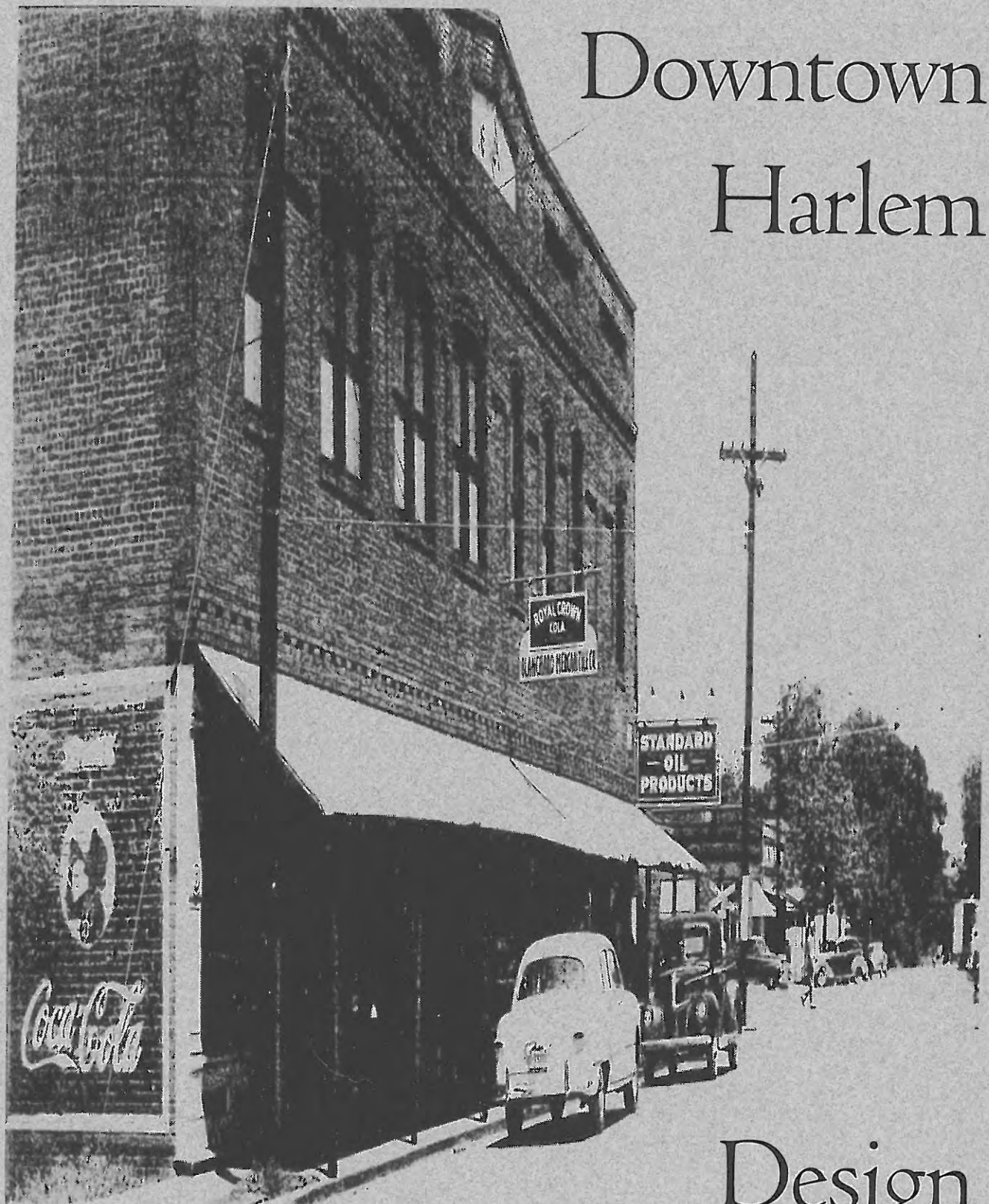

Design Guidelines

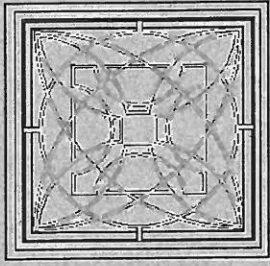

prepared by:

Piedmont Preservation
Madison, Georgia
www.piedmontpreservation.com

prepared for:

City of Harlem
Historic Preservation
Commission

Harlem, Georgia

guidelines

INTRODUCTION

contents

introduction

background 2
district 3
process 4
context 6
character 8

commercial

shape, placement, & scale 12
materials & details 14
storefronts 16
entrances 18
windows 20
awnings 22
signs 24
site 26

industrial

shape, placement, & scale 30
materials & details 32
entrances 34
windows 36
awnings 38
signs 40
site 42

appendix

standards 46
glossary 48
reference 52

preface

This booklet was initiated by the Harlem Historic Preservation Commission and financed in part by the City of Harlem on behalf of its current and future citizens. The purpose of this booklet is to provide information on local preservation initiatives, the design review process, and the historic context and visual character that define downtown Harlem. The remainder of the booklet outlines design guidelines for commercial and industrial areas. The guidelines listed and illustrated here are designed to assist decision makers --- property owners, developers, contractors, and commissioners --- in developing design solutions which satisfy Harlem's historic preservation ordinances.

historic preservation ordinance

To "preserve, enhance, and perpetuate those aspects of the city having historical, cultural, architectural, and archaeological merit," the City of Harlem adopted a historic preservation ordinance on April 8, 2002. The ordinance is designed to preserve the community's identity and historic character, promote harmonious growth in relationship to historic properties, to strengthen community pride and awareness of historic assets, to stabilize property values and encourage investment in historic areas, to capture the benefits of tourism and economic development, and to maintain and protect historic properties. By preserving its unique historic character, the City ensures that future generations will enjoy the benefits of Harlem's rich heritage.

historic preservation commission

The Historic Preservation Ordinance establishes the Harlem Historic Preservation Commission (HPC), the volunteer board which serves as the city's preservation program. The HPC is charged with the responsibility of initiating local designation and design review, public education and awareness, and preservation planning and research. The Commission has five appointed members, who serve two-year terms without monetary compensation. Because of the work of the HPC, the City of Harlem also qualifies as a Certified Local Government (CLG) community. CLG status enables the municipality to apply for a variety of preservation grant and funding opportunities at the state and federal levels.

historic district

Recognizing the value of Harlem's historic buildings and neighborhoods, the Harlem Historic Preservation Commission initiated a Historic Resource Survey in 2003 to identify and research historic properties within the area. Its findings indicated that a significant portion of the city was eligible for inclusion in a locally designated historic district.

The City of Harlem then adopted a local ordinance formally designating the recommended area as a local historic district. Local designation provides for the preservation and protection of the community's historic properties through the design review process. This booklet provides design guidance for that portion of the historic district which contains historic commercial and industrial character buildings.



What is design review?

The Historic Preservation Ordinance provides for a design review process. Design review consists of the evaluation of any proposed exterior work upon a designated property. Both minor and extensive projects must be reviewed and approved prior to beginning work. The design review process is often triggered by a building permit application; however, building permits can not be issued until design review is complete. Although some types of work projects, such as installation of a fence or a satellite dish, may not require a building permit, design review is still required.

Which properties require design review?

All designated properties require design review. Designated properties include all properties within the historic district and any individually designated sites. Please note that design review covers both historic and non-historic properties in a historic district. The city's Official Zoning Map shows all designated districts and properties. A visit to City Hall can confirm whether or not a property is designated.

What type of work requires design review?

All work involving a change to an exterior feature of a designated property requires design review. Projects that physically alter the property include but are not limited to:

- ▶ changes in site or setting,
- ▶ repair or rehabilitation,
- ▶ relocation or demolition, and
- ▶ new construction or additions.

Neither interior alterations nor a change in the use of the property require design review. The Historic Preservation Ordinance applies only to the external appearance of the property and regulates neither zoning nor land use. Ordinary maintenance does not require design review.

What is a Certificate of Appropriateness?

When planning a work project, an owner must submit a completed application for a Certificate of Appropriateness (COA). Applications are available from and should be submitted to City Hall. Please contact City Hall for the application deadline, regular meeting date, and regular meeting time.

Utilizing design guidelines and the general standards for the rehabilitation of historic properties, the HPC must decide to approve or deny the application. If the application is approved, a Certificate of Appropriateness is issued and design review is complete.

What should an application include? In order that the Commission may make an informed decision, completed applications must be accompanied by support materials. Illustrations may include site plans, elevations, and floor plans drawn to a standard architectural scale, e.g. 1/4 inch equals one foot. Photographs of the building, site, and neighboring properties are also helpful. Support materials may differ according to the type and size of the project. The application and support materials must be submitted at the same time.

What could happen if work begins before design review? If work is initiated prior to approval of a COA application or to obtaining a building permit, a stop work order may be issued. If these requirements are not met, the property owner may face fines or an order to restore the original condition of the property.

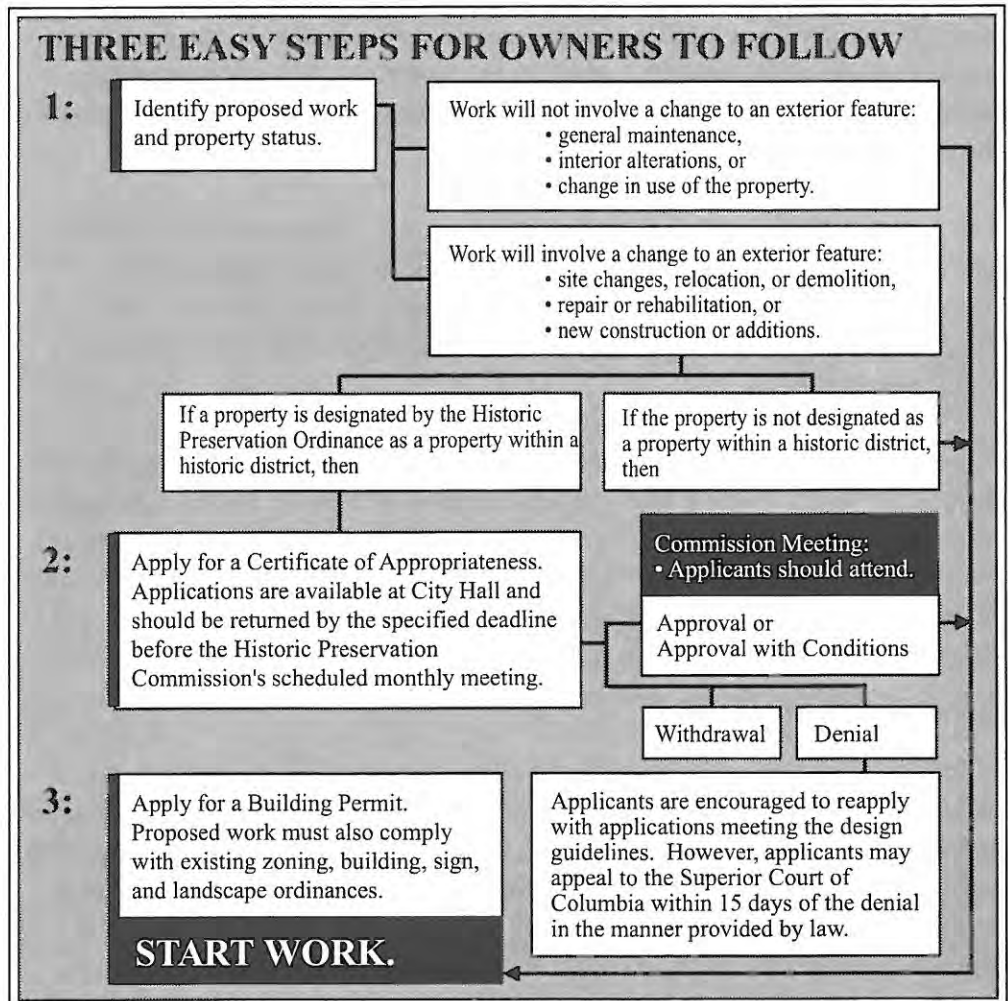

guidelines

INTRODUCTION

context

Harlem is located in Columbia County which was created by an act of the state legislature from a northern part of Richmond County on December 10, 1790. In the colonial era the territory that constitutes Columbia County was laid out as part of St. Paul Parish. Named for Christopher Columbus, the county was created in response to a request by backcountry settlers that they be given court sessions that would be more convenient than those held in Augusta.



Cotton became the major cash crop in the area following the invention of the cotton gin by Eli Whitney in 1793. The close proximity of Augusta and its Cotton Market was especially convenient in the early days when transportation was limited to wagon and boat. The coming of the railroad provided even greater access to markets and served as a stimulus for the inception of Harlem.

The Georgia Railroad was laid through the county between 1834 and 1836. The main stop in Columbia County became Saw Dust, a lumber town founded around 1840, a mile west of the present City of Harlem. Travelers often stayed overnight in the town, which sold liquor and bore a reputation of being a little wild.

Following the Civil War many residents of Saw Dust became embittered over the sale of liquor in the town. Among these was Newnan Hicks, a railroad engineer, who quit his job and vowed to start a town of his own. Mr. Hicks built his home near Dr. Andrew Sanders who had been promoting settlement in the area by selling land for one dollar an acre and donating land for churches and schools. Within five years Hicks, Sanders, and several others won incorporation of the town on October 24, 1870.

Lined with big oaks and blessed with good drinking water, the town was a haven for many Augustans, especially during summer outbreaks of smallpox and cholera, said Patricia Ann Moore, whose ancestors were among the first residents. Harlem received its name from a resident of New York visiting relatives. He said the community reminded him of the then fashionable and elite section of New York. Acceptance of the name reflected the popular



opinion of the time that Harlem would become a residential suburb of Augusta which in turn was thought destined to become the metropolis of the South.

By 1913, Harlem had about 500 residents and boomed with a oil/fertilizer plant, the Columbia Opera House, Hicks Hotel, Grady High School, electric lights along the road and in homes, two drugstores, three meat markets, two gin mills, a cotton warehouse, three hardware stores, 12 grocery stores, two clothing stores, a newspaper and 10 passenger trains daily.

A 1917 fire destroyed the electric plant, Opera House and several buildings.

Possibly more damaging was the effect of the boll weevil through the 1920s on the cotton economy in the county and the later mechanization of cotton farming. Columbia County lost one quarter of its population between 1920 and 1930. Timber farming replaced cotton to some extent but was much less labor intensive. Nonetheless, the town remained a small, vital community through the last part of the twentieth century. As Harlem enters the twenty-first century the early prediction of suburban ties to Augusta may yet come true as the metropolitan area continues to expand.



commercial buildings

The core of historic downtown Harlem is comprised of what are described as commercial buildings. While the term *commercial* is used to describe these buildings other uses have occurred in them especially in two story examples which may have housed offices, lodges, and living space. These buildings share common characteristics in their shape, size, placement, materials, etc. Taken together they create a visual character area distinct from residential and industrial areas. While the goals of historic district guidelines all aim for the same goal, preserving the character of the district, specialized guidelines aid in this process. Pages 16 - 31 deal specifically with this area.

common features of commercial buildings

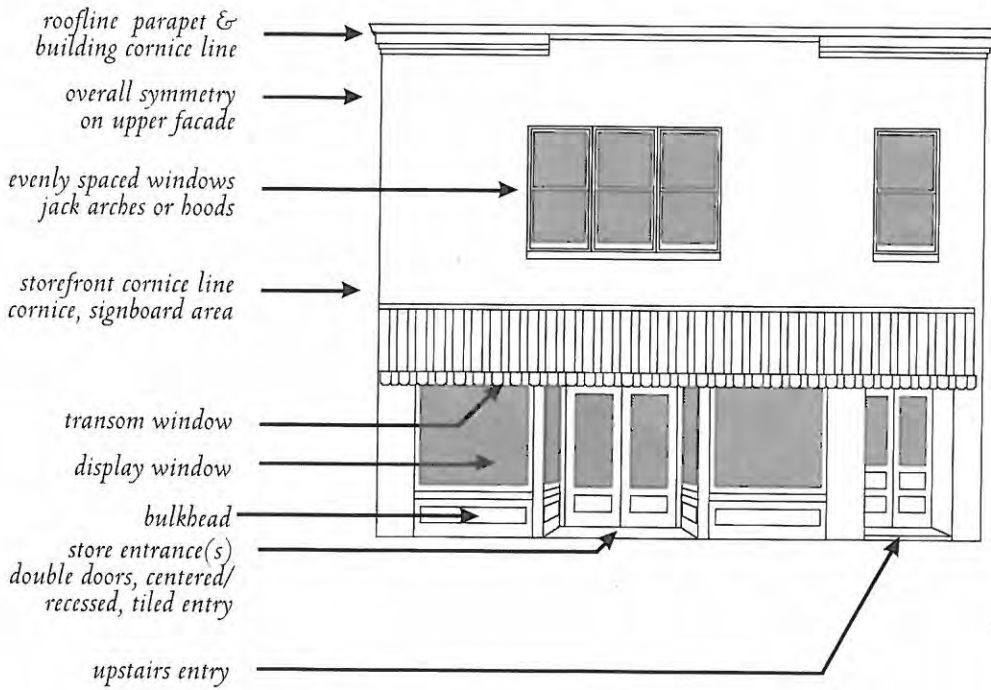

industrial buildings

Adjacent to the commercial area is an area with buildings that are best described as industrial in character. Though described as *industrial* they may have been warehouses or retail spaces. The term industrial describes the utilitarian nature their design and materials convey. Taken together they create a visual character area distinct from the commercial area and the adjacent residential areas. While the goals of historic district guidelines all aim for the same goal, preserving the character of the district, specialized guidelines aid in this process. Pages 16 - 31 deal specifically with this area.

common features of industrial buildings

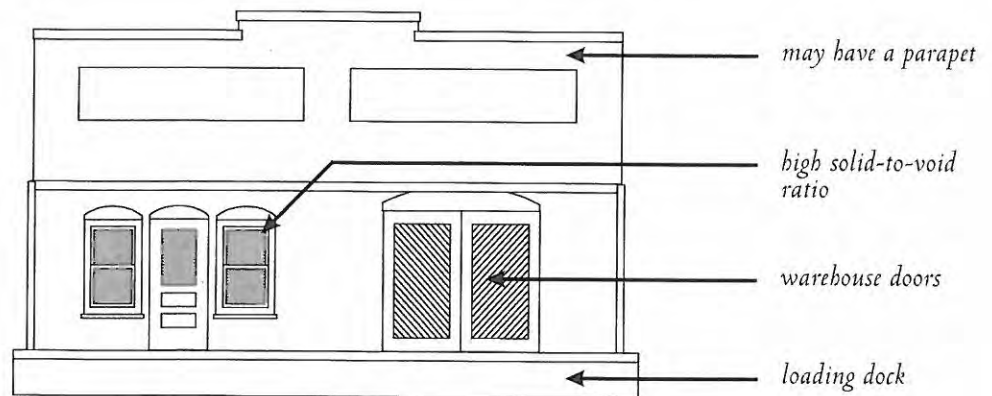

design

GUIDELINES

commercial



commercial SHAPE,

design

PLACEMENT & SCALE

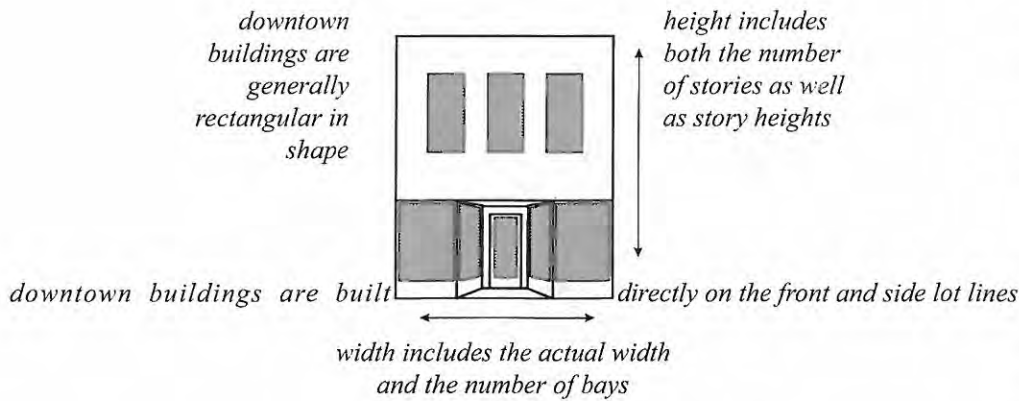

Shape is comprised the *facade* (or *silhouette*) of a building and the *footprint* (or *floor plan*) of a building.

Scale is the size of a building relative surrounding structures - its height, width, and depth. The combination of these elements lends a sense of massiveness, verticality, or horizontality. Scale also incorporates two proportional components: *stories* (the horizontal divisions) and *bays* (the vertical divisions). The alignment of stories and the repetition of bays is a significant aspect of historic area scale.

Placement - referring to where a building will be located upon a lot - includes both *setback*, how far the building is from the front property line, and *spacing*, the distance between buildings on adjacent lots.

Similarity of shape, scale, and placement ties buildings in downtown together and sets them apart from neighboring residential areas. While individual buildings may distinguish themselves from their neighbors by using differing parapet shapes or cornice treatments, most usually follow a similar overall pattern. Generally, buildings are an upright rectangular block placed on the front and side lot lines.

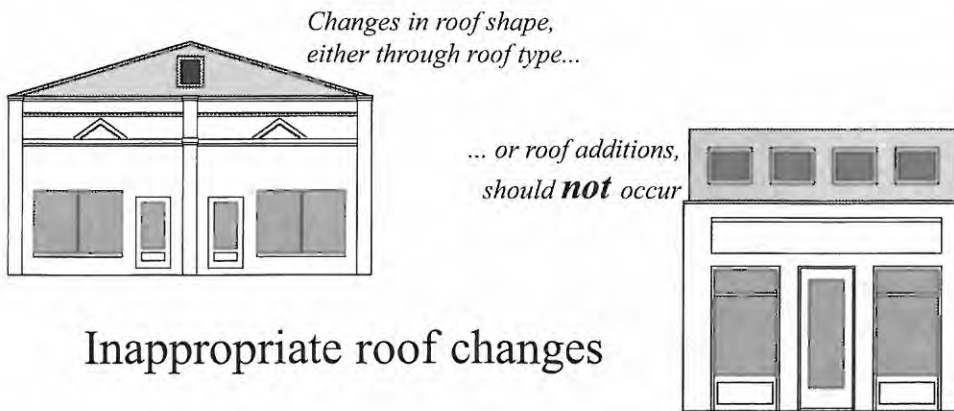

Inappropriate roof changes

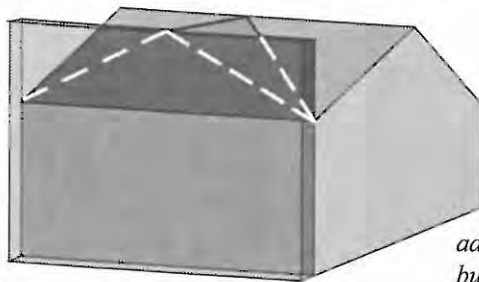

adding a parapet would help a building with a non-conforming shape better fit the district

preservation

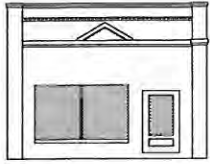

- changes to roofing and roof shape should remain hidden behind the parapet
- additions should occur at the rear of the building
- additions should be in scale with the building
- rooftop additions should be avoided
- rear additions may be partial or full width
- preserve historic skylights whenever possible

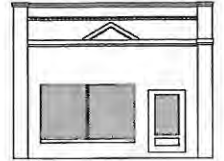

reclamation/adaptation

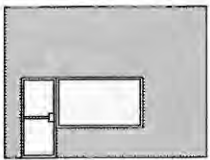

- add a parapet to hide inappropriate roof forms
- raise front wall (parapet) height to match historic examples
- extend front wall to create a zero lot line facade

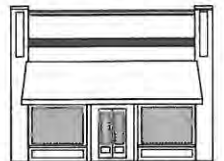

creation

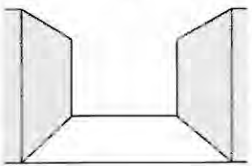

- place buildings at the front lot line
- corner buildings should be set on the lot line for both streets
- abutt neighboring structures – use party walls
- limit height to one or two stories
- use the same story and parapet heights as historic examples
- facades should be rectilinear – hide roofs behind parapets
- single story buildings should be between 20 feet and 30 feet – larger buildings may be created by connecting storefronts
- two story buildings should generally be a single storefront plus an upstairs entry or a double storefront plus and upstairs entry

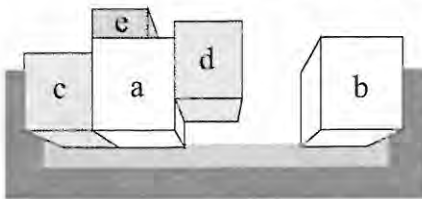
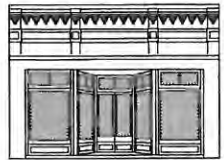

Historic commercial buildings (a & b) provide the template for placement. New buildings should follow this pattern (c) not break it (d). Additions are best placed at the rear (e).

New construction should not use nontraditional roof forms or footprints such as this building.

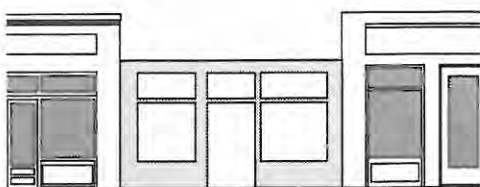
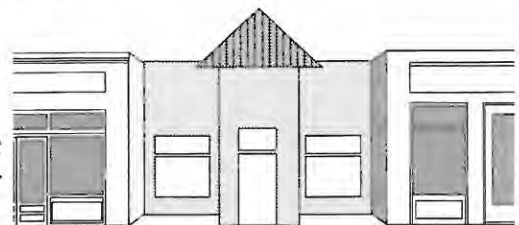

Though this new building has the same rectilinear form and number of stories as its historic neighbors, it fails to match their height due to a lower roofline and the lack of a parapet.

commercial MATERIALS

design

& DETAILS



Covering a structure's exterior to "update" or change its appearance robs the building of its historic character and negatively impacts the entire district.

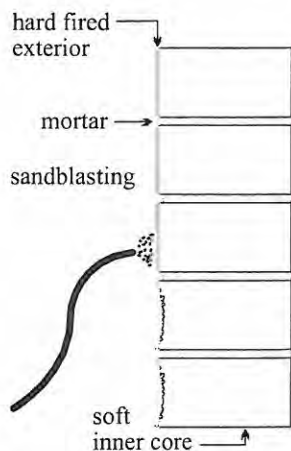

Sandblasting brick removed the protective exterior of historic bricks leading to the eventual complete deterioration of the material. Pressure washing can be detrimental as well damaging soft mortar and forcing moisture into the interior of the walls.

The shaded areas represent the traditional locations of architectural detail on historic commercial buildings. In Harlem, ornamental brickwork is the primary type of detail and should provide a template for new facades.

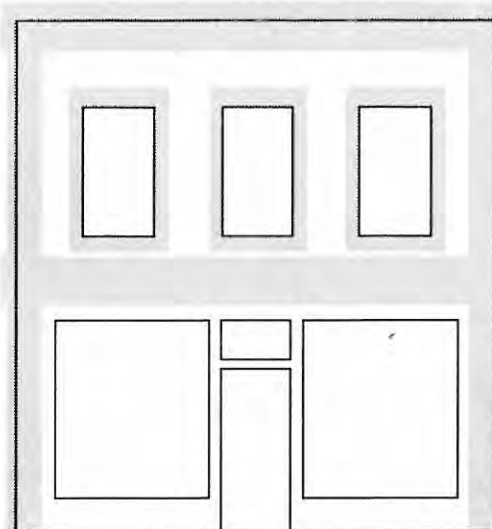

The exterior surface of a building is a primary design element. Exterior surfaces, whether applied or structural, contribute to building design in terms of: *type, unit size, pattern, texture, and color.* Brick is the exclusive primary material in Harlem. Additionally, secondary materials such as the wood, cast-iron, canvas, etc. of other design components, contribute to visual character.

Architectural detailing is a significant component of historic and visual character. *Details* - features that embellish the structure - often reflect the particular style, age, and use of a historic building and are found in varying degrees. Harlem's commercial buildings generally have modest detailing consisting of patterned brick work. Such stylistic features are usually found in particular locations. For instance, architectural details may be located along or upon the building roofline, parapet, or cornice. Another common area for ornamentation is around the upper windows. Details are also predominant along the storefront cornice and contribute to storefront design.

preservation

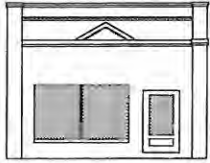

- preserve historic exterior materials and details
- do not paint or “waterproof” unpainted historic masonry
- never cover historic materials with synthetic materials
- repair damaged exterior materials and details in-kind
- replace only the area of damage rather than total replacement.
- repointing brick using a historic mortar mix – match original mortar strength, color, and joint profile
- clean exterior materials using the gentlest means possible – never sandblast
- use matching materials on additions; clapboard maybe considered for small additions to brick buildings
- use a degree of ornamentation equal to the original or less

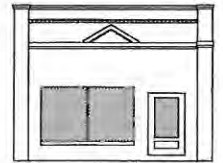

reclamation/adaptation

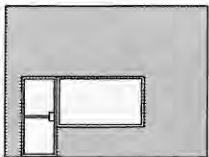

- remove non-historic material covering original material when possible
- non-historic brick with a non-traditional color may be painted with an appropriate color
- use historic photographs and other documentation to recreate original details
- create cornices above the storefront and at the top of the parapet
- add pilasters at corners and between storefronts



creation

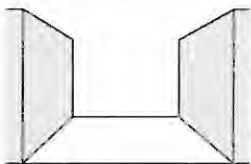

- use unpainted red brick laid in a running bond for facade walls
- use gray or buff colored mortar – avoid white mortar
- include recessed panels in the parapet
- include decorative brickwork at the roof line, above the storefront, and separating stories
- consider pilasters at the corners and between storefronts

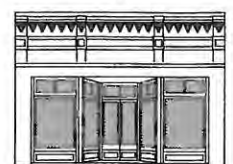

Materials such as:

E.F.I.S. (synthetic stucco)

varigated brick

& concrete block/CMUs

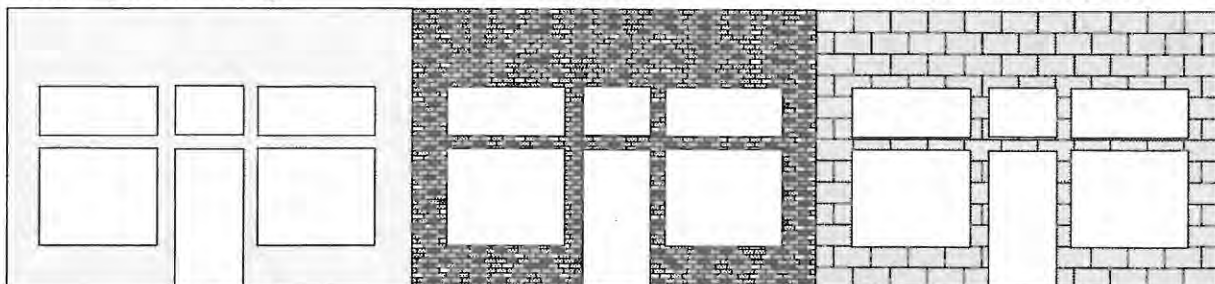

are inappropriate for the district.

commercial STOREFRONT

design

Transoms should not be covered or filled in. Those previously closed should be reopened.

Bulkheads should remain wood. Later, brick bulkheads - especially those of Roman brick - should be replaced or covered with wood.

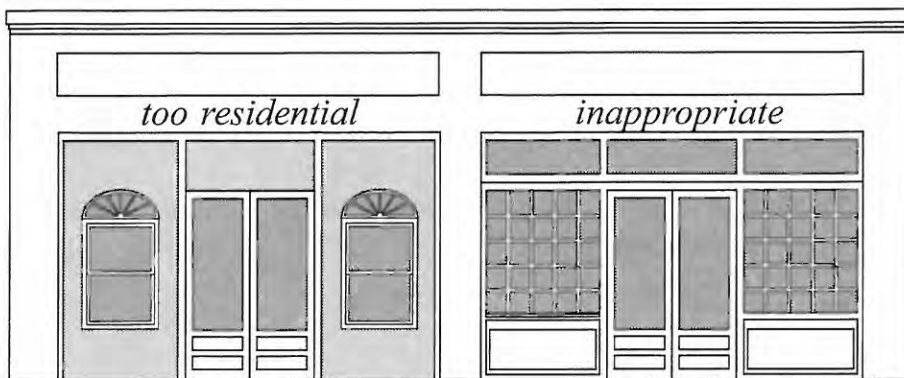

Display windows, transoms, and bulkheads should not be replaced with sash windows - even for a change in use. Multi-pane display windows are "colonial" in appearance and not appropriate for Harlem's downtown.

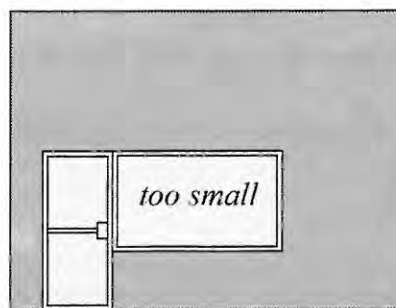
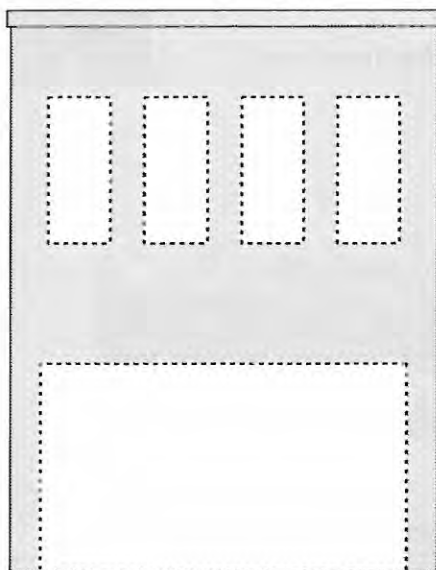

Historic downtown buildings have open first floors (low solid-to-void ratio as shown at left). New buildings should replicate this pattern avoiding large amounts of solid such as (above)

Storefronts are a distinctive feature of downtowns. The **storefront** - the ground floor level of the typical commercial building - is designed to display merchandise and attract customers. Residentially scaled doors and windows predominated until the early nineteenth century when cast iron and mass-produced plate glass created more open storefronts.

Historic storefront design typically includes: the primary entrance, large display windows, pier or column supports between the windows, panels known as bulkheads beneath the windows, a transom row above the windows, and ornamental details. The **storefront configuration** - the particular arrangement of storefront features - is significant to the building's visual character.

preservation

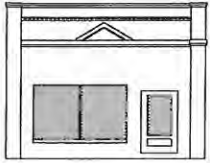

- preserve historic elements – bulkheads, window frames, and cast iron columns – through maintenance and repair
- replace historic elements beyond repair with elements matching in design and materials
- maintain the historic open nature of the storefront
- keep transoms open - do not cover or use for a/c units

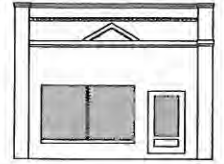

reclamation/adaptation

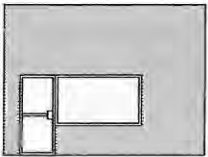

- reopen closed transoms
- replace “raw” aluminum window frames with wood (preferred), powder coated aluminum, or anodized aluminum
- replace or cover later brick bulkheads on historic buildings with wood bulkheads
- lengthen existing openings to create bulkheads and transoms – transoms should be in the same opening as the main window and separated by framing (not wall material)
- reclaim original storefront dimensions on historic buildings
- restoration based on historic photographs is encouraged
- resize storefronts of non-historic buildings to match historic buildings - follow guidelines for new storefronts

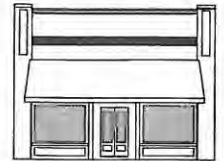

creation

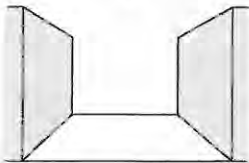

- orient the storefront to the street not to a parking lot
- limit the width of storefronts: generally one storefront for every 25 - 30 feet
- use traditional bay divisions: either columns or piers
- use similar solid-to-void ratios as historic examples - use transoms, display windows, and bulkheads
- glass should be clear not tinted
- wood bulkheads are encouraged, brick bulkheads with recessed panels and similar decorative details may be approved

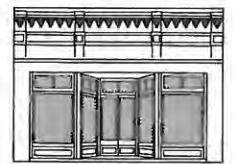

commercial ENTRANCE

design

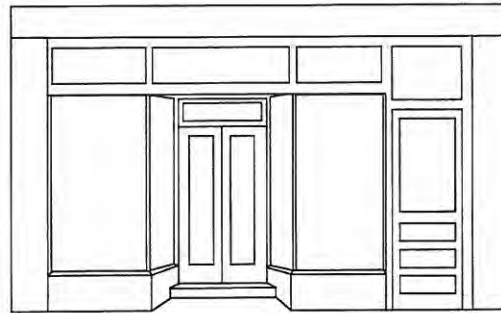
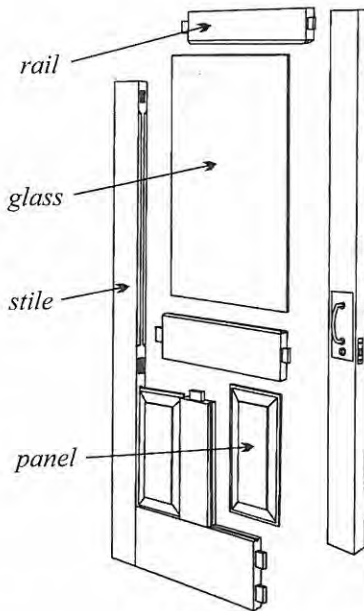

Primary entrances to historic commercial buildings are generally located at the center of their storefronts (see p. 16). Two story buildings often have a second facade entrance providing access to the upper floor. Historic doors consist of several components which can be repaired separately rather than entirely replacing the door.

Entrances reflect the original design and use of a building. Placement and size, designed to facilitate the movement of people and goods through the structure, commonly distinguish the **primary entrance** from the **secondary entrance**. The primary entrance - usually centralized and accentuated within the storefront design or on the building facade - offers a prominent location for customer and client access; whereas, secondary entrances are set apart or located on side elevations to serve utilitarian purposes, such as service/delivery and upper floor access.

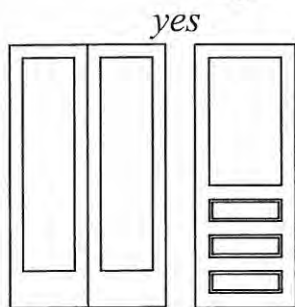

Generally, doors on the facades of downtown buildings have large areas of glass.

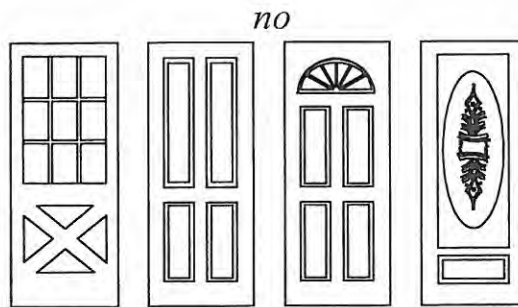

Residential doors are out of place in the historic commercial setting and should be avoided.

In downtown business areas, entrances are emphasized. Entrance design encompasses: **the location, the configuration (recessed and/or canted approaches), tiled entry floors, and door number, type and material**. Central placement of the primary entrance within the storefront is very common, as is the use of recessed, double doors and above-door transom windows. Generally, doors are simple in design, framed and constructed of wood, and reveal large amounts of glass to allow an interior view. Door hardware may be more elaborately decorated.

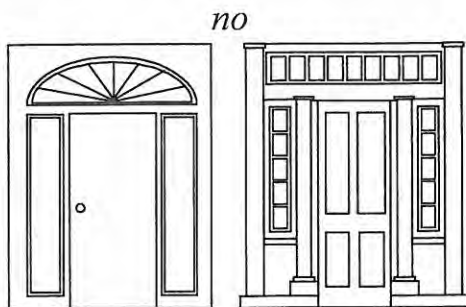

The elements surrounding the door are equally important. Elaborate surrounds are not typical downtown.

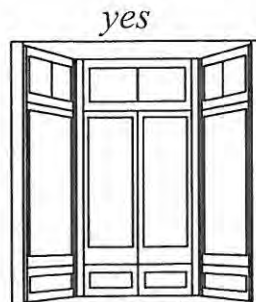

Traditionally surrounding elements are limited to transoms.

preservation

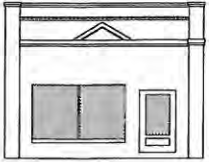

- preserve historic doors and hardware through maintenance and repair
- replace historic doors beyond repair with doors matching in design and materials
- original facade entrances should remain unchanged: do not move, add, or enclose facade entrances
- keep transoms open - do not cover or use for a/c units
- traditional wood screen doors are appropriate: do not install raw aluminum screen doors or any type of storm doors

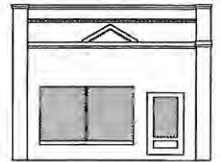

reclamation/adaptation

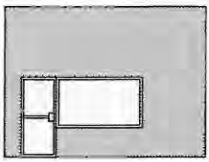

- replace inappropriate doors
- three-quarter glazed doors are most appropriate for primary entrances
- half glazed doors are appropriate for secondary facade entrances
- do not use paneled, oval glazed, or other residential style doors on facades
- wood frame doors are best; brush painted metal may be considered
- exterior hardware should be traditional in design
- glazing should be clear and uniform - do not use tinted glass, stained glass or leaded glass
- reopen closed transoms
- avoid narrow or single sidelights - consider double doors or a wider single door instead
- see “storefront design” also, p.

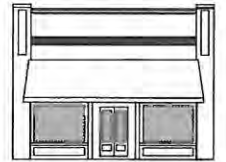

creation

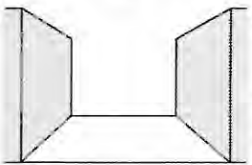

- central, primary entrances are most appropriate; mirror image double storefront are also acceptable
- primary entrances should orient the building to the street
- corner entrances are appropriate for properties located at intersecting streets; corner entrances oriented to adjacent parking are not appropriate
- recessed, canted entrances are preferred
- three-quarter glazed doors are most appropriate for primary entrances
- two story buildings may have an upper floor entry on the facade
- half glazed doors are appropriate for secondary facade entrances
- do not use paneled, oval glazed, or other residential style doors
- wood frame doors are best; brush painted metal may be considered
- entrances should have transoms
- see “storefront design” also, p.

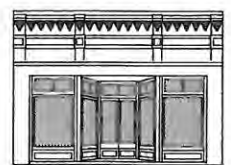

commercial WINDOWS

design

In addition to storefront windows (p. 6) commercial buildings have windows on upper stories as well as side and rear elevations. The more traditional, regularly spaced *upper windows* offer light and ventilation for upper offices/living spaces and often possess additional stylistic detailing. Side elevations often have "above shelving" windows: small, fixed windows placed high the wall to allow wall space for display shelving. Rear elevations may have windows for a manager's office or may lack them entirely in the case of warehouse space.

Window construction generally includes several components: *sashes, rails, stiles, muntins, panes, and sills*. Window design encompasses *shape, dimension, grouping, spacing, type or operation, pane arrangement, material, and detailing*. Typically window design places an emphasis on building symmetry. Upper windows are more likely to feature architectural detailing and window accessories, such as shutters, screens, and storm windows.

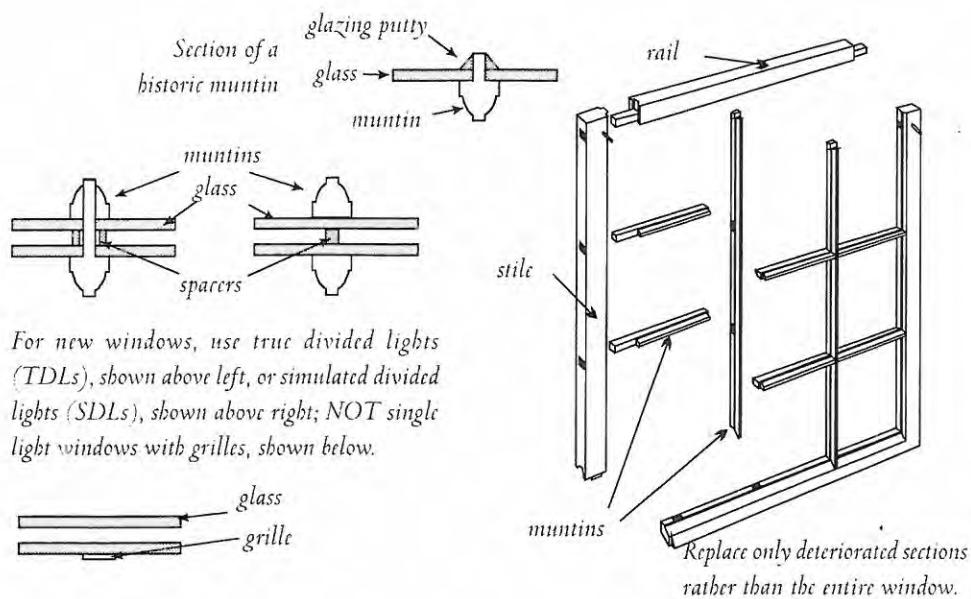

For new windows, use true divided lights (TDLs), shown above left, or simulated divided lights (SDLs), shown above right; NOT single light windows with grilles, shown below.

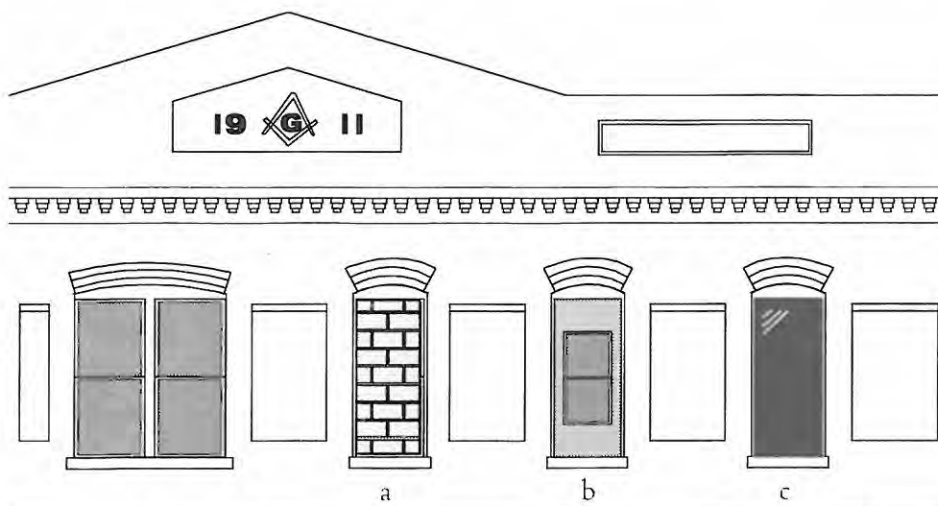

Windows should not be closed in (a), reduced in size (b) or replaced with single fixed panes (c).

preservation

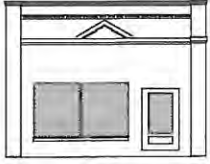

- preserve historic windows through maintenance and repair
- replace historic windows beyond repair with doors matching in design and materials
- original facade window openings should remain unchanged: do not add, enclose, or change dimension
- new window openings may be added on side and rear elevations: use matching material, use approximate size of historic examples, approximate design of historic examples. Use the same guides for windows in additions
- storm windows should match the color of the window frame and obscure the window as little as possible
- preserve historic shutters through maintenance and repair; when adding shutters reflect the building's original design

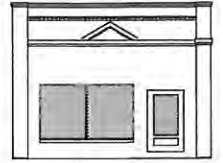

reclamation/adaptation

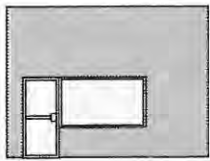

- replace inappropriate windows
- reopen enclosed windows
- double-hung sash windows are most appropriate for upper facades

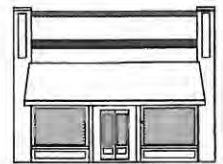

creation

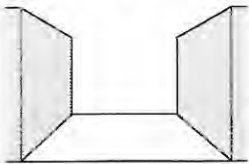

- windows should approximate size, shape, placement, and configuration of historic examples
- double sash windows are most appropriate for upper stories
- upper facade windows should either be symmetrically placed or reflect the lower portion of the building
- upper side and rear elevation windows should generally be symmetrically placed
- lower side elevation windows may be asymmetrically placed
- lower side elevation windows may be either double sash windows or small, "above shelving" windows
- rear elevation windows should generally be double sash windows

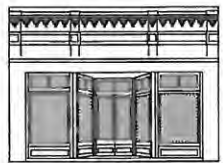

commercial AWNING

design

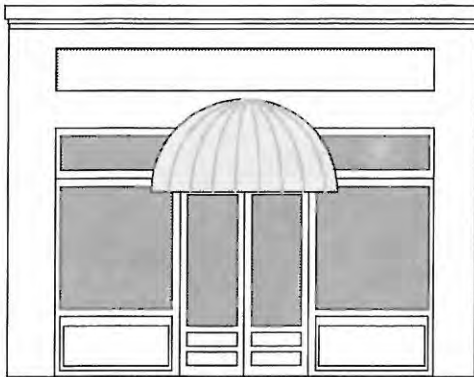

*Awnings should **not** be shaped differently than the opening.*

*Awnings should **not** be out of scale and proportion to the building and should not cover details.*

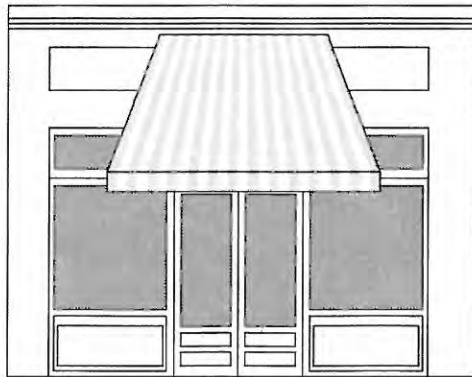

*Awnings should **not** cover more than one storefront even if a single business occupies both buildings.*

Throughout the years, downtown merchants have found a variety of ways to shelter the walks in front of their businesses. Shelter structures, such as *awnings and canopies* created a haven from the weather for potential customers encouraging them to view display windows. Such structures also served to ornament buildings and shade interiors.

In terms of awning design, the important aspects include *placement, shape, size, and material*. Canvas awnings that extend the full width of a storefront or fit within the individual storefront openings are the most traditional. Likewise, many buildings of the early twentieth century utilize canopies to emphasize their horizontal lines; such flat, metal canopies often feature decorative pressed tin cresting along the upper edge. Porches are primarily limited to civic and institutional facilities that reference a particular architectural style. Historic illumination of awnings is rare.

preservation

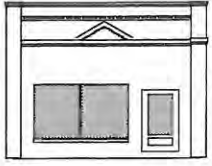

- preserve historic awnings through maintenance and repair

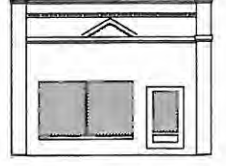

reclamation/adaptation

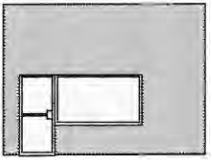

- remove wood shingled awnings
- non-historic awnings may be removed

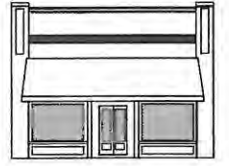

creation

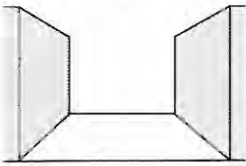

- use canvas or metal for awning material
- match awnings shape to the shape of the window or door opening
- fit awning within the frame of the window or doorway without covering architectural detail
- plastic internally lit awnings are not appropriate

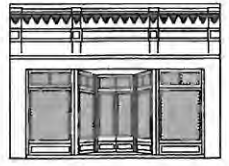

commercial SIGN

design



Signs should be placed in traditional locations on the building of which there are many including: sign board area, projecting, awnings, and windows.

*New signs should respect the size scale, and design of the building. Do **not** cover architectural features of the building with signs.*

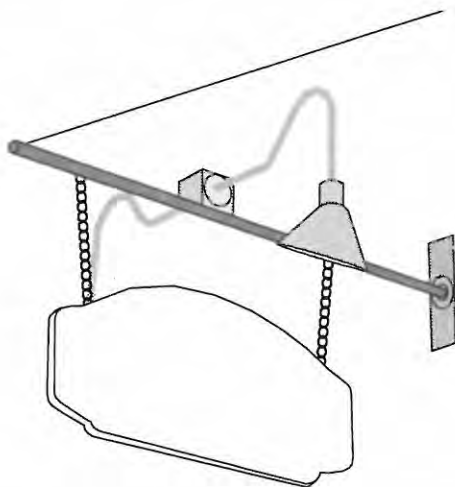
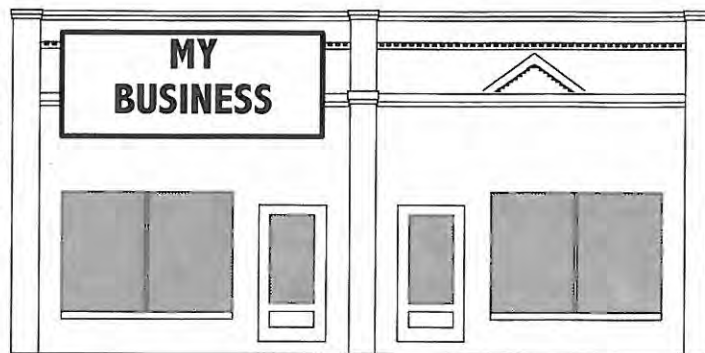

When used, sign lighting should be achieved with small directed lights with a limited pool of light.

In the downtown area, signs are a traditional and distinctive feature. Signs identify business establishments, building names, products sold, and service provided. Signs are also subject to frequent changes as business arrive, relocate, or update. Nonetheless, signs on historic buildings downtown generally have always been placed in certain traditional locations. These locations complement the architecture of the building and relate buildings to one another. Since signs contribute significantly to the visual character of the area, inappropriate and competitive signage can have a tremendous negative impact.

Signs are typically categorized by placement, such as *wall sign, hanging sign, window sign, sidewalk sign, projecting sign, awning sign*. Freestanding signs (signs located on poles or independent structures) are not characteristic of the downtown area, with the exception of modern public traffic and safety signs. High-style or public buildings often bear permanent signs which are incorporated into the structure, such as *cornerstones (construction markers), incised lettering (surface inscriptions), and tiled entries*. Sign design encompasses placement, size, material, shape, and lighting.

preservation

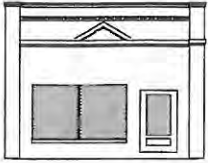

- preserve painted “ghost” signs on side walls
- install new signs in such a manner as to not alter or destroy historic materials or details

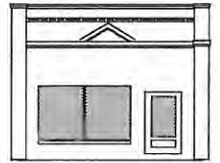

reclamation/adaptation

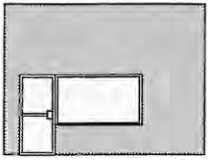

- remove internally lighted, plastic signs
- remove rooftop signs

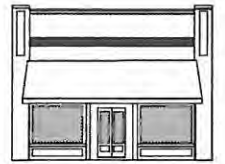

creation

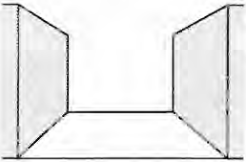

- signs must conform to the City of Harlem sign ordinance.
- limit the number of signs to the minimum necessary for identification purposes
- use traditional sign locations
- use sign of a scale appropriate for the building and the district
- use painted wood or metal, or materials closely resembling such, for attached and hanging signs
- use simple shapes or shapes found on the building
- do not attach to roofs or cover architectural details
- lighting, when needed, should be achieved with small, directed lighting
- exterior neon signs are not appropriate
- window signs should cover no more than 25% of the window

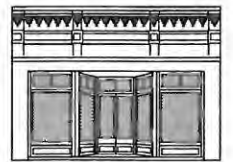

commercial SITE

design

& MODERN FEATURES

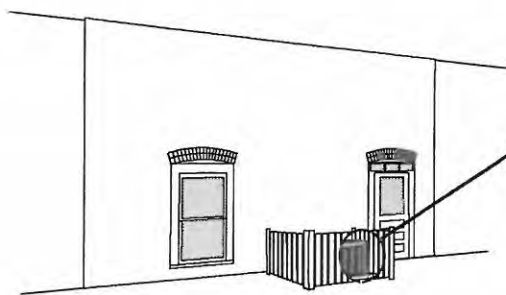
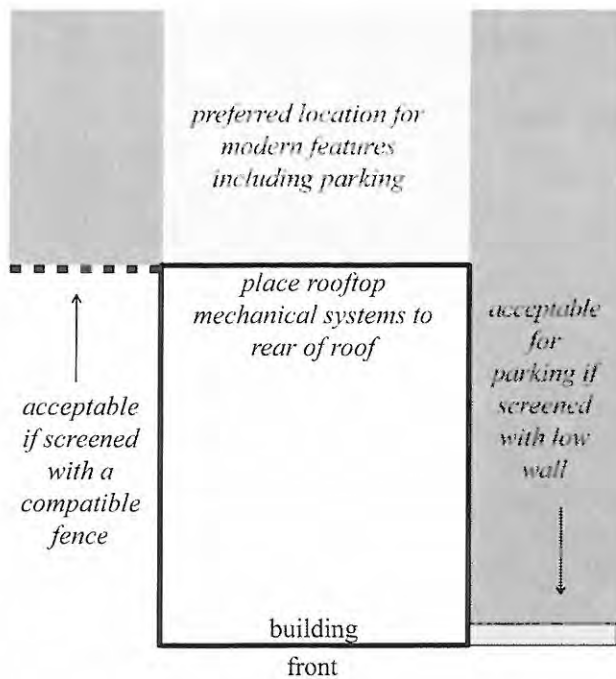

Locate mechanicals at the rear of buildings and screen behind simple fencing.

Roof top mechanicals should **not** be placed near the facade where they are visible from the street.

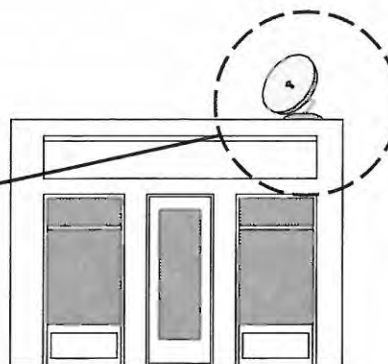

Downtown buildings nearly always touched their front and side lot lines leaving little area for any sort of site features. These back lots were generally of a utilitarian nature serving as loading or storage areas. Storeowners often fenced such areas either for security or to screen less than orderly storage of equipment or refuse. Modern features are just that - equipment and functions not used in the past such as dumpsters, mechanical systems, and parking areas. Both fences and modern features should have limited visibility when used in downtown.

Fences were nearly always placed to the rear of properties. Tall wood or metal fences provided the screening and security business owners sought. Residential types, such as picket fences, were generally not used. Masonry walls also were not typical, but may be appropriate for screening parking. Parking, mechanical systems, and dumpsters are best kept at the rear and screened by fencing. Exterior lighting often did not occur on facades, whereas rear elevations often had utilitarian fixtures.

preservation

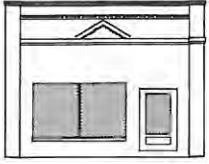

- never demolish historic buildings to achieve parking
- preserve historic fencing through maintenance and repair

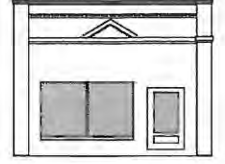

reclamation/adaptation

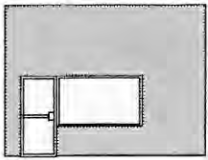

- screen existing parking from public view: use low brick walls along traditional facade lines and vegetative screens elsewhere

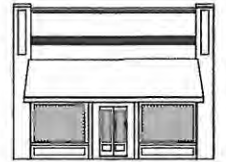

creation

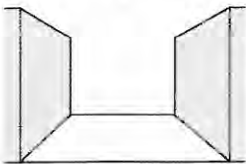

- place mechanical systems behind the building and out of the public view
- place rooftop mechanical systems, utility meters and security lighting unobtrusively
- facade lighting should be kept to a minimum and use a simple design: round globe lights are preferred
- rear elevation lighting should be utilitarian in nature
- place security fencing behind the building as unobtrusively as possible
- use wood plank or metal fences between 4 and 6 feet high - avoid pickett fencing and chainlink fencing
- place parking as unobtrusively as possible – preferably behind buildings
- parking pavement: concrete is preferred; asphalt is allowed; gravel will be considered
- screen parking from public view: use low brick walls along traditional facade lines and vegetative screens elsewhere

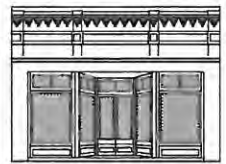

design

GUIDELINES

industrial



industrial SHAPE

design

& PLACEMENT

Shape is comprised of several aspects that together give a building its particular silhouette and footprint. The *facade* or *silhouette* of a building is defined by the outside lines of the building when looking at its front and sides. The *footprint* or *floor plan* of a building is formed by the lines of the exterior walls of the buildings if drawn upon the ground. Other aspects are the height of the foundation, story heights, and whether a building is composed of a single block or several smaller blocks. *Placement* - referring to where a building will be located upon a lot - includes both *setback*, how far the building is from the front property line, and *spacing*, the distance between buildings on adjacent lots.

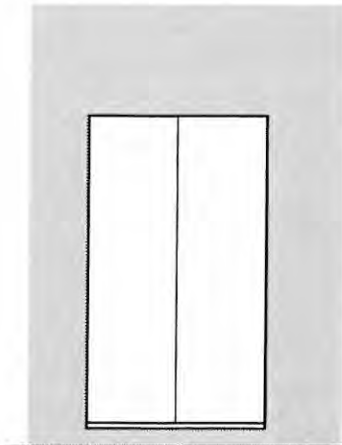

Shallow setbacks are encouraged. Buildings with front gable roofs or parapets are the best choice when using such placement.

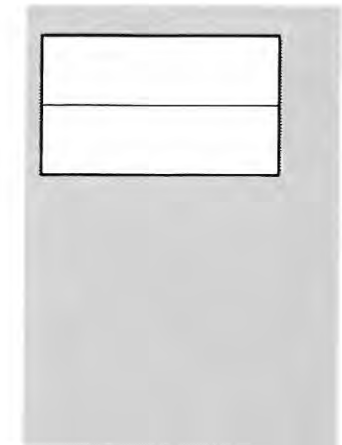

Deeply setback buildings have also occurred in this area historically. Buildings with side gable roofs or parapets are the best choice when using such placement.

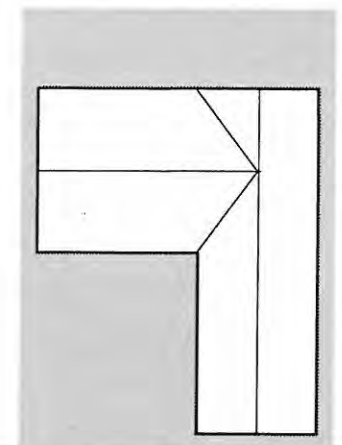
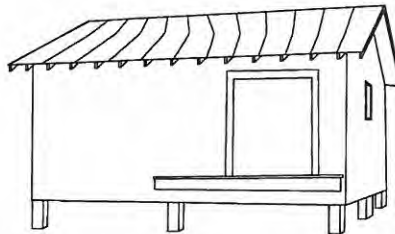

L-shaped, cross gable buildings with a combination setback may also be considered.

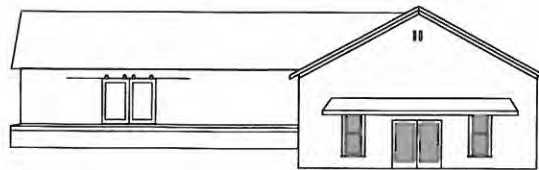

Like the nearby commercial buildings, industrial buildings also bear a great similarity of form to each other based primarily on utility. Most are one story rectangular blocks with front facing gables with or without simple parapets. Historically some may have had low shed roofs as well. Placement is also fairly uniform though not quite as rigid as the placement of commercial buildings. Generally, buildings are placed close to the front lot line. Unlike commercial buildings, industrial buildings do not abut their side walls.

preservation

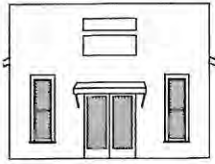

- changes to roofing and roof shape should remain hidden behind the parapet on those buildings with parapets
- maintain roof shape on buildings with no parapet
- additions should occur at the rear of the building or on the sides toward the rear of the building
- additions should be in scale with the building
- rear additions may be partial or full width

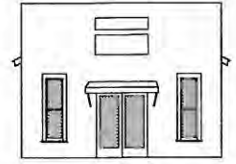

reclamation/adaptation

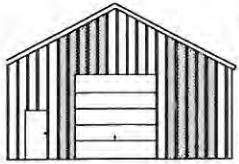

- parapets may be added as part of a complete facade adaptation of front lot line buildings
- build-outs to the front lot line following the *creation* guidelines may occur on buildings setback from the street



creation



- place buildings near the front lot line using a similar setback as historic examples (preferred) or toward the rear along the rear lot line
- roofs with front gables, square, or stepped parapets are encouraged for front lot line buildings
- roofs with side gables are encouraged for rear lot line buildings
- gable roofs should have moderate to steeply pitched similar to historic examples
- do not abut neighboring structures
- limit height to one story
- use the same story and parapet heights as historic examples

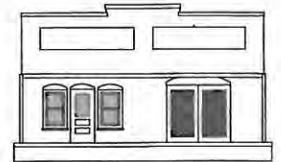

industrial MATERIALS

design

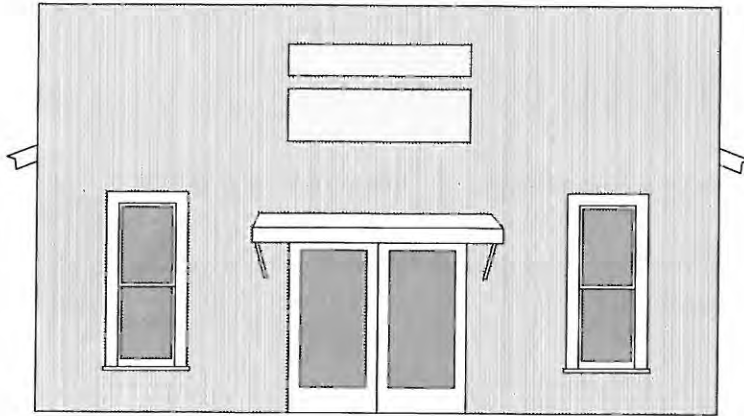

Many of Harlem's few remaining industrial buildings were built with economical, utilitarian materials such as corrugated sheet metal or concrete block. Replacing or covering these original materials - e.g. with clapboard or brick - robs the building of its historic character.

NO!

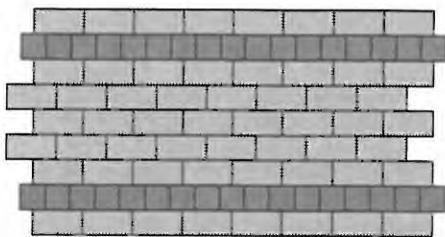
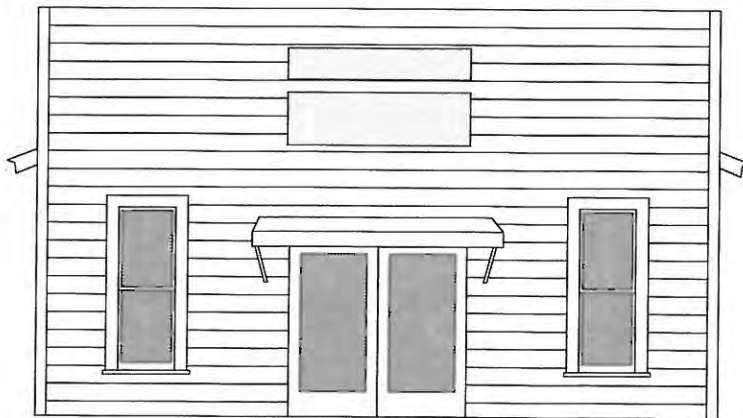

Most historic industrial buildings constructed of brick used a common bond - the brick pattern shown at left consisting of "header" rows (bricks laid side to side) separated by 5, 6, or 7 "stretcher" rows (bricks laid end to end). New brick construction should use the same pattern.

The exterior surface of a building is a primary design element. Both economy and security against theft or fire hazard were considered when constructing industrial enterprises. Thus, some were frame buildings with wood or metal sheathing while others were constructed of brick. Later concrete block became an option that answered both concerns. Most industrial buildings have no detailing.

Exterior surfaces, whether applied or structural, contribute to building design in terms of: **type, unit size, pattern, texture, and color.** Few industrial buildings remain in downtown. The use of red brick, whether used only on the facade or for the entire building, is appropriate and encouraged. Corrugated metal, concrete block, or wood are also traditional materials.

preservation

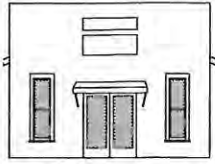

- preserve historic exterior materials and details
- do not paint or “waterproof” unpainted historic masonry
- never cover historic materials with synthetic materials
- repair damaged exterior materials and details in-kind
- replace only the area of damage rather than total replacement.
- repointing brick using a historic mortar mix – match original mortar strength, color, and joint profile
- clean exterior materials using the gentlest means possible – never sandblast
- use matching materials on additions; clapboard maybe considered for small additions to masonry buildings

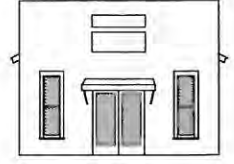

reclamation/adaptation

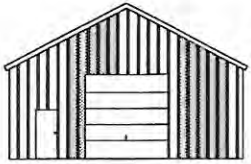

- remove non-historic material covering original material when possible
- non-historic brick with a non-traditional color may be painted with an appropriate color



creation

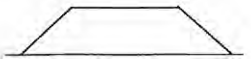

- use the following materials (listed in order of preference): brick, corrugated metal, wood clapboard, wood vertical board, painted concrete block
- use unpainted red brick laid in a common bond
- use gray or buff colored mortar – avoid white mortar
- avoid decorative detailing

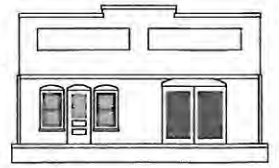

industrial WINDOWS

design

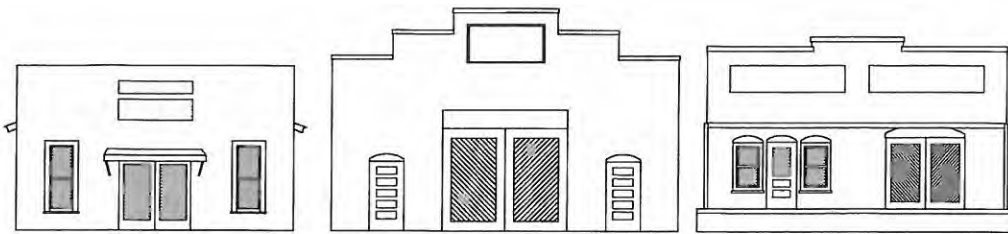

Industrial character buildings rarely use display windows opting for double hung windows instead. Facades may or may not be symmetrical though openings are generally balanced.

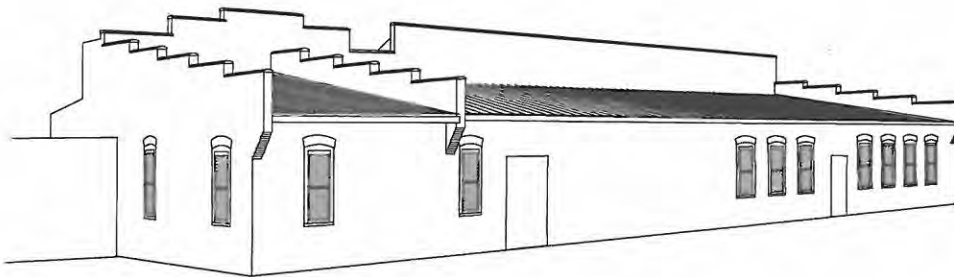

Side elevations, like facades, do not follow a rigid pattern of placement. Solid (blank wall) is often more prevalent than void (windows) sometimes to the extent of having no windows at all.

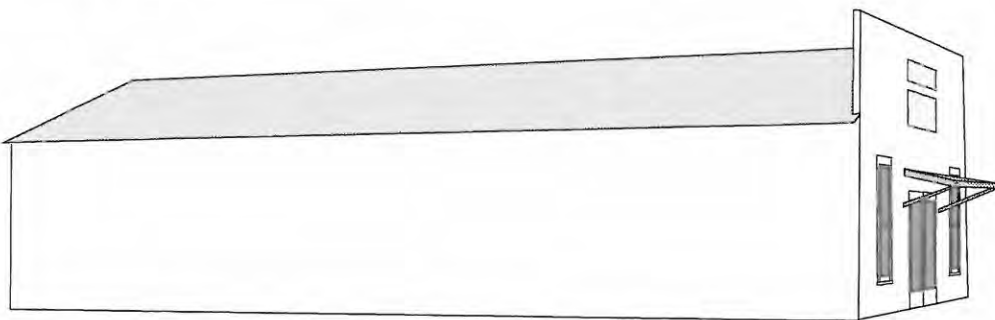

Windows on industrial buildings, typically simple sash windows, served to provide light and ventilation for office and work areas. Storage areas, on the other hand, did not need windows and were more secure without them. Consequently, window placement on industrial buildings does not follow rigid rules.

Window construction generally includes several components: *sashes, rails, stiles, muntins, panes, and sills*. Window design encompasses *shape, dimension, grouping, spacing, type or operation, pane arrangement, material, and detailing*. Windows in the industrial area will typically be simple sash windows with no architectural detail. Display windows are rare. In some instances, glass block may be considered.

preservation

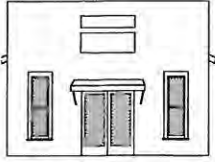

- preserve historic windows through maintenance and repair
- replace historic windows beyond repair with doors matching in design and materials
- original facade window openings should remain unchanged: do not add, enclose, or change dimension
- new window openings may be added on side and rear elevations: use matching material, use approximate size of historic examples, approximate design of historic examples. Use the same guides for windows in additions
- storm windows should match the color of the window frame and obscure the window as little as possible

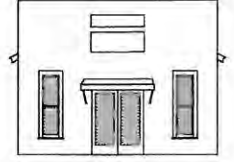

reclamation/adaptation

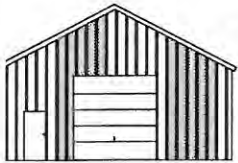

- replace inappropriate windows
- double-hung sash windows are most appropriate
- display windows may be considered on some facades
- side elevation windows may be either double sash windows or small, “above shelving” windows

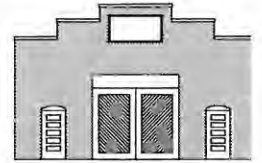

creation

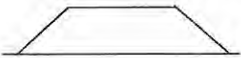

- windows should approximate size, shape, placement, and configuration of historic examples
- double sash windows are most appropriate
- display windows may be considered on some facades
- windows may be asymmetrically placed
- side elevation windows may be either double sash windows or small, “above shelving” windows

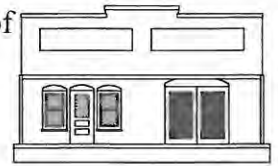

industrial ENTRANCE

design

Residential style doors are not appropriate for use on buildings in the industrial character areas.

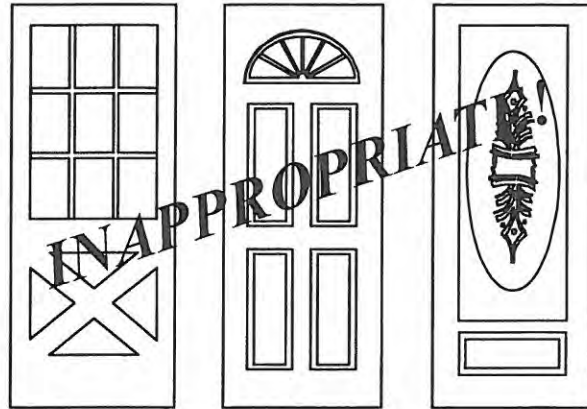

Industrial buildings typically have two types of entrances: entry doors for people and warehouse doors for goods. The interior layout of the building generally determined the placement of doors and did not follow a rigid pattern. Buildings often have a pedestrian entrance from the street and warehouse doors facing street or railroad access.

Pedestrian doors are simple in design, framed and constructed of wood, and may have glass though solid panel doors are common as well. Warehouse doors are usually paired, constructed of wood, and either hinged or hung on an overhead track.

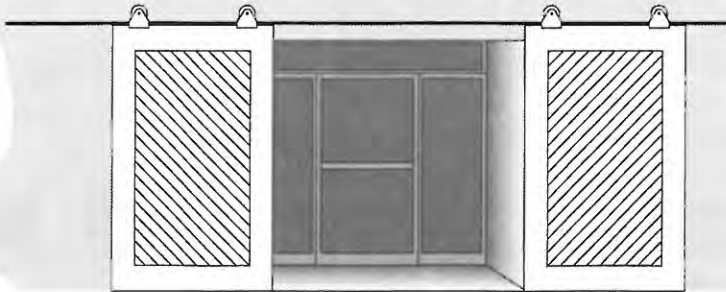

Be creative! Warehouse doors can lead to a recessed entrance,

or open to an "indoor patio" allowing for al fresco dining on pleasant days.

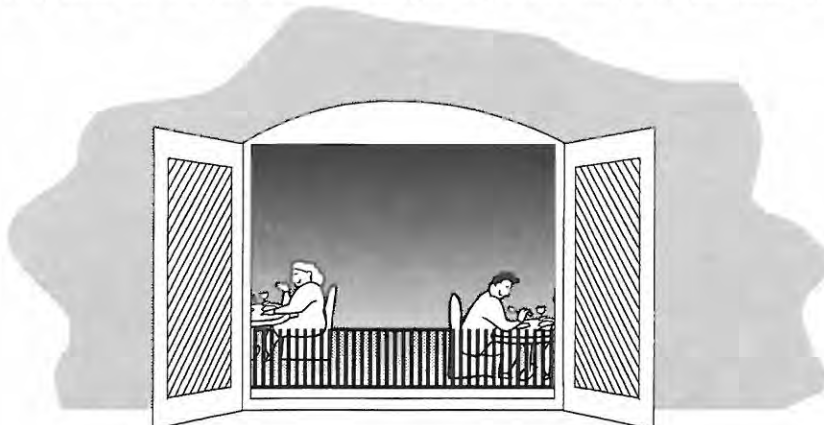

preservation

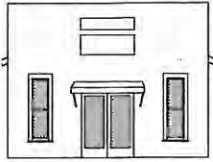

- preserve historic doors and hardware through maintenance and repair
- replace historic doors beyond repair with doors matching in design and materials
- original facade entrances should remain unchanged: do not move, add, or enclose facade entrances

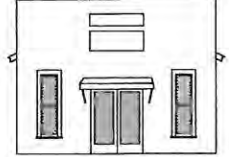

reclamation/adaptation

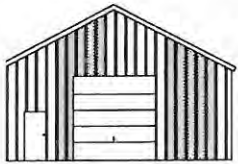

- replace inappropriate doors
- cross panelled doors or half glazed doors are most appropriate for primary entrances
- do not use fanlight glazed, oval glazed, or other residential style doors on facades
- traditional warehouse doors are appropriate
- wood frame doors are best; brush painted metal may be considered
- exterior hardware should be traditional in design
- avoid the use of sidelights and transoms

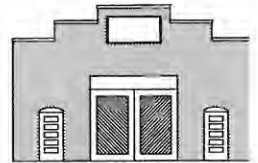

creation



- primary entrances should orient the building to the street
- cross panelled doors or half glazed doors are most appropriate for primary entrances
- do not use fanlight glazed, oval glazed, or other residential style doors on facades
- traditional warehouse doors are appropriate
- wood frame doors are best; brush painted metal may be considered
- exterior hardware should be traditional in design
- avoid the use of sidelights and transoms

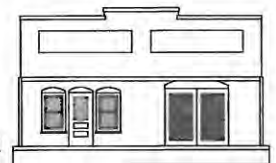

industrial AWNING

design

& LOADING DOCK

Industrial character buildings often have raised loading platforms - almost like porches. These may be located on the front, sides, or rear of the building. Many have solid shed awnings or flat canopies to shelter them.

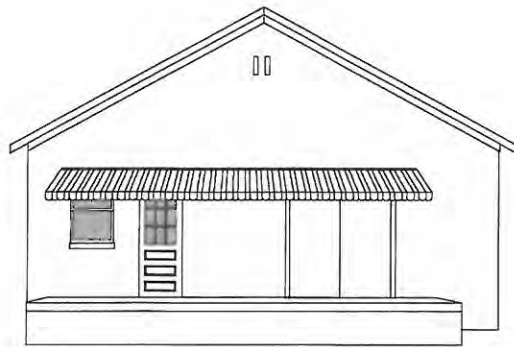

Industrial establishments often utilized elevated platforms or docks to facilitate the loading and unloading of goods from vehicles. These structures were located on front and side elevations for loading wagons and later trucks. Buildings along the railroad would generally have docks on the rear elevation. These docks were generally sheltered by some type of awning to protect the materials being loaded as well as those temporarily stored on the dock. Entrances sometimes had awnings as well.

In terms of awning design, the important aspects include *placement, shape, and material*. Awnings for industrial buildings are limited to entrances and rarely are found over windows. Loading docks shelters are either partial or, more often, full width having no relation to the openings on the building. Unlike awnings for commercial buildings, canvas awnings are rarely used, metal being the material of choice. Shed awnings and flat canopies are used almost exclusively. Shed awnings are generally supported with brackets though simple posts are sometimes used. Flat canopies are supported from above by turnbuckles.

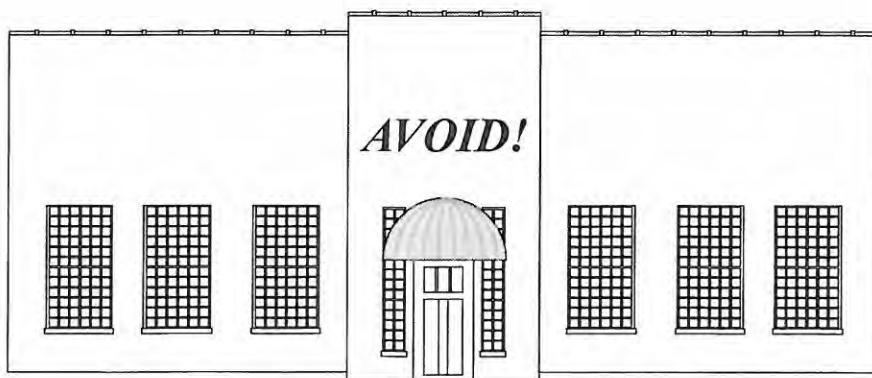

*Canvas commercial style awnings are a poor choice for industrial character buildings. Awnings and canopies should always fit the shape of the opening it shelters. Bubble awnings should **not** be used.*

preservation

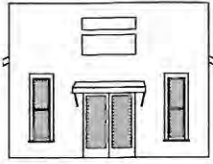

- preserve historic awnings through maintenance and repair
- historic loading docks should remain in place: do not remove
- code required railings should be industrial in character; preferably constructed of metal

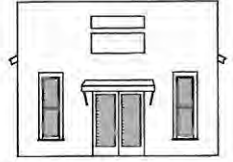

reclamation/adaptation

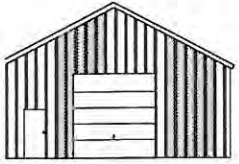

- non-historic awnings may be removed
- metal shed awnings or flat canopies may be added
- loading docks may be added to the facade, side or rear: use poured concrete, concrete block, or wood
- code required railings should be industrial in character; preferably constructed of metal

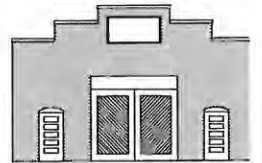

creation



- metal shed awnings or flat canopies may be used
- loading docks may be placed on the facade, side or rear: use poured concrete, concrete block, or wood
- code required railings should be industrial in character; preferably constructed of metal

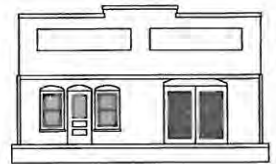

industrial SIGN

design

Like on commercial buildings, the parapet is a traditional signboard area for industrial character buildings

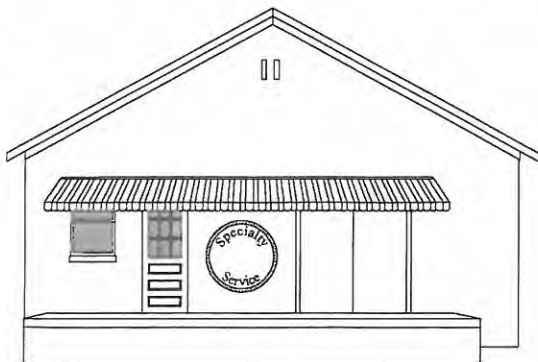
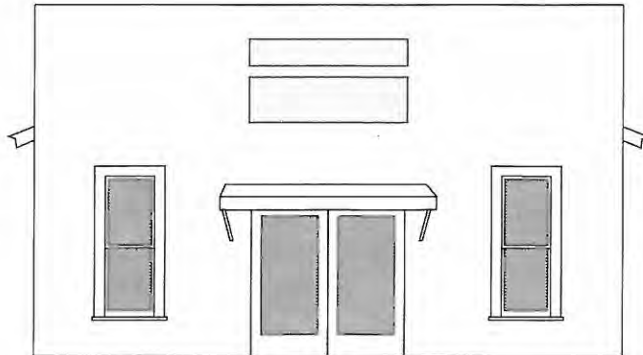

The front wall near the doorway is also traditional.

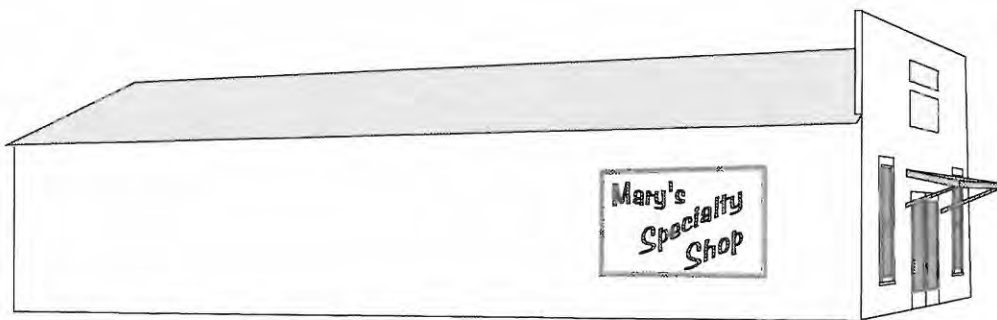

The blank walls of industrial buildings may be considered for signs as well.

In the industrial area, signs are a traditional and distinctive feature. Signs identify business establishments, products sold, and service provided. Signs are also subject to frequent changes as business arrive, relocate, or update. The signs of neighboring industrial buildings are not necessarily as uniform as those of neighbors in the commercial area. Historically industrial signs were larger than those on commercial buildings. Since signs contribute significantly to the visual character of the area, inappropriate and competitive signage can have a tremendous negative impact.

Signs are typically categorized by placement, such as *wall sign*, *window sign*, or *projecting sign*. Freestanding signs (signs located on poles or independent structures) are not characteristic of the industrial area. Sign design encompasses *placement*, *size*, *material*, *shape*, and *lighting*.

preservation

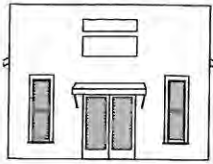

- preserve painted “ghost” signs on side walls
- installation of new signs in such a manner as to not alter or destroy historic materials or details

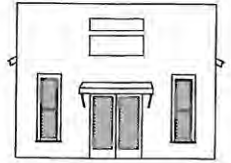

reclamation/adaptation

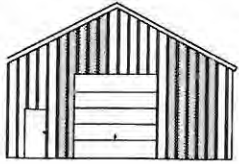

- remove internally lighted, plastic signs
- remove monument signs

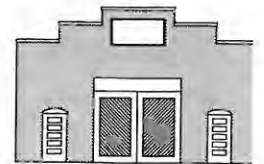

creation



- signs must conform to the City of Harlem sign ordinance.
- limit the number of signs to the minimum necessary for identification purposes
- use traditional sign locations
- painted wall signs may be considered
- use sign of a scale appropriate for the building and the district
- use painted wood or metal, or materials closely resembling such, for attached and hanging signs
- use little ornament on signs or for sign shape
- do not attach to roofs
- lighting, when needed, should be achieved with small, directed lighting
- exterior neon signs are not appropriate
- window signs should cover less than ?% of the window

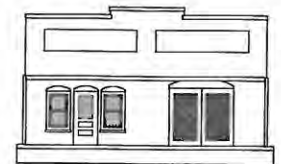

industrial SITE

design

& MODERN FEATURES

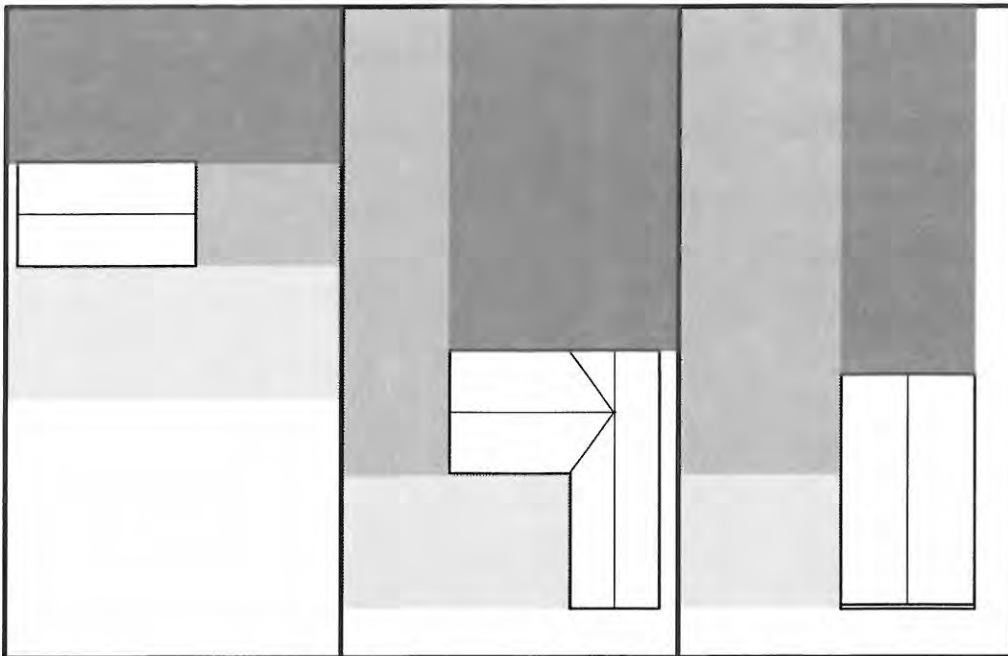

Industrial character properties placed little emphasis on the aesthetics of site features generally opting for the most functional placement. Nonetheless, in order to present a tidy appearance and for improved security, most storage yards were located to the rear.

Fences were nearly always placed to the rear of properties. Tall wood or metal fences provided the screening and security business owners sought. Residential types, such as picket fences, were generally not used. Mechanical systems and dumpsters are best kept at the rear and screened by fencing. Exterior lighting often did not occur on facades, whereas rear elevations often had utilitarian fixtures.

As in the commercial area the impact of the automobile should be kept to a minimum. However, because industrial character properties are not always placed at the front lot line parking areas toward the front of the property may be considered. Parking should always be placed as unobtrusively as possible.

- *Best location for all modern features: parking, mechanicals, fencing*
- *Acceptable location for all modern features: parking, mechanicals, fencing*
- *Inappropriate location for mechanicals and fencing; parking may be considered here*

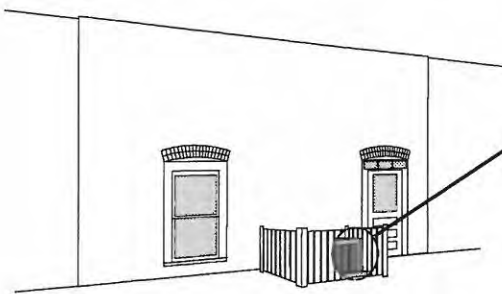

Locate mechanicals at the rear of buildings and screen behind simple fencing.

Lighting should be utilitarian NOT decorative.



preservation

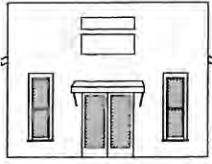

- never demolish historic buildings to achieve parking
- preserve historic fencing through maintenance and repair

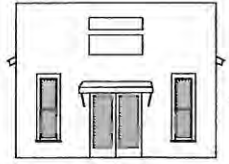

reclamation/adaptation

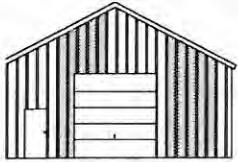

- remove inappropriate chainlink fencing

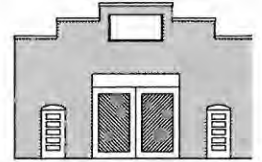

creation



- place mechanical systems behind the building and out of the public view
- place rooftop mechanical systems, utility meters and security lighting unobtrusively
- exterior lighting should be utilitarian in nature
- place security fencing behind the building as unobtrusively as possible
- use tall wood plank or metal fences - avoid pick fencing and residential height chainlink fencing
- place parking as unobtrusively as possible

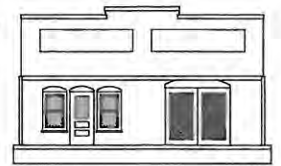

guidelines

APPENDIX



secretary of the interior's standards for rehabilitation

The Secretary of the Interior's Standards, developed in 1975 and revised in 1983 and 1992, present the general principles of historic preservation in a succinct and clear manner. These standards are also available in annotated and illustrated versions. The following standards are to be applied to specific rehabilitation projects in a reasonable manner, taking into consideration economic and technical feasibility.



-
- * A property shall be used for its historic purpose or given a new use that requires minimal change to its distinctive materials, features, spaces, and spatial relationships.
 - * The historic character of a property shall be retained and preserved. The removal of distinctive materials or alteration of features, spaces, and spatial relationships that characterize a property shall be avoided.
 - * Each property shall be recognized as a physical record of its time, place, and use. Changes that create a false sense of historical development, such as adding conjectural features or elements from other historic properties, shall not be undertaken.
 - * Changes to a property that have acquired historic significance in their own right shall be retained and preserved.
 - * Distinctive materials, features, finishes, and construction techniques or examples of craftsmanship that characterize a property shall be preserved.
 - * Deteriorated historic features shall be repaired rather than replaced. Where the severity of deterioration requires replacement of a distinctive feature, the new feature shall match the old in design, color, texture, and where possible, materials. Replacement of missing features shall be substantiated by documentary and physical evidence.
 - * Chemical or physical treatments, if appropriate, shall be undertaken using the gentlest means possible. Treatments that cause damage to historic materials shall not be used.
 - * Archeological resources shall be protected and preserved in place. If such resources must be disturbed, mitigation measures shall be undertaken.
 - * New additions, exterior alterations, or related new construction shall not destroy historic materials, features, and spatial relationships that characterize the property. The new work shall be differentiated from the old and shall be compatible with the historic materials, features, size, scale and proportion, and massing to protect the integrity of the property and its environment.
 - * New additions and adjacent or related new construction shall be undertaken in such a manner that, if removed in the future, the essential form and integrity of the historic property and its environment would be unimpaired.

Addition. New construction added to an existing building or structure.

ADLs. "Actual Divided Lights" refers to window sashes which have muntins that hold separate panes of glass. Historic windows are constructed in this manner. See also SDLs and grilles.

Alteration. Work which impacts any exterior architectural feature including construction, reconstruction, or removal of any building or building element.

Arch. A curved construction which spans an opening and supports the weight above it.

Awning. A sloped projection supported by a frame attached to the building facade or by posts anchored to the sidewalk.

Bay. The horizontal divisions of a building, defined by windows, columns, pilasters, etc.

Bond. A term used to describe the various patterns in which brick is laid.

Bracket. A decorative support feature located under eaves or overhangs.

Bulkhead. The panel between framing members and beneath the display windows in a storefront. Also known as a kickpanel.

Canopy. A flat projection from the building facade for the storefront and pedestrian traffic.

Capital. Topmost member of a column or pilaster.

Cast iron. Iron made in a mold.

Cast iron front. A storefront made of glass and pieces of utilitarian and decorative iron cast in easily assembled parts.

Column. A vertical, cylindrical or square supporting member, usually with a classical capital.

Coping. The capping member of a wall or parapet.

Corbeling. A series of stepped or overlapped pieces of brick or stone forming a projection from the wall surface.

Cornice. The uppermost, projecting part of an entablature, or feature resembling it.

Crenellation. A parapet with open spaces that surmounts a wall and is used for defense or decoration

Course. A horizontal layer or row of stones or bricks in a wall.

Dentil. One of a series of small, square, tooth or block-like projections forming a molding.

Double hung window. A window having two sashes, one sliding vertically over the other.

Eave. The edge of a roof that projects beyond a wall.

E.I.F.S. Exterior insulation and finish systems (EIFS) are multi-component exterior wall systems which generally consist of: 1) an insulation board; 2) an adhesive and/or mechanical attachment of the insulation board to the substrate or existing wall surface; 3) a base coat reinforced with glass fiber mesh on the face of the insulation board; and 4) a finish coat which protects the entire system.

Elevation. Any of the external faces of a building.

Entablature. The horizontal group of members supported by the columns, divided into three major parts, it consists of architrave, frieze, and cornice.

Facade. The front elevation or “face” of a building.

Fanlight. An semicircular or semi-elliptical window with radiating muntins suggesting a fan.

Fascia. A projecting flat horizontal member or molding; forms the trim of a flat roof or a pitched roof; also part of a classical entablature.

Fenestration. The arrangement of window openings in a building.

Finial. A projecting decorative element at the top of a roof turret or gable.

Flat arch. An arch with wedge shaped stones or bricks set in a straight line. Also known as a Jack arch.

Flashing. Thin metal sheets used to make the intersections of roof planes and roof/wall junctures watertight.

Footprint. The outline of a building’s ground plan from a top view.

Foundation. The lowest exposed portion of the building wall, which supports the structure above.

Frame construction. A method of construction in which the major parts consists of wood.

French door. A door made of many glass panes, usually used in pairs and attached by hinges to the sides of the opening in which it stands.

Frieze. The middle horizontal member of a classical entablature, above the architrave and below the cornice.

Gable. The triangular upper portion of a wall to carry a pitched roof.

Gable roof. A pitched roof with one downward slope on either side of a central, horizontal ridge.

Ghosts. Outlines or profiles of missing buildings, details, elements, historic signs, etc.

Grilles. Flat elements of wood or plastic attached to the exterior of windows or sandwiched between panes to simulate a divided light sash, though generally without successfully replicating the look of historic windows. See also ADLs and SDLs.

Header. A brick laid with its end toward the face of the wall.

Hood molding. A projecting molding above an arch, doorway, or window, originally designed to direct water away from the opening; also called a drip mold.

Infill. New construction where there had been opening before. Applies to a new structure such as a new building between two older structures or new material such as block infill in an original window opening.

Jack arch. see Flat arch

Jamb. The vertical side of a doorway or window.

Keystone. The top or center member of an arch.

Light. A single pane of glass.

Lintel. A horizontal beam over a door or window which carries the weight of the wall above; usually made of stone or wood.

Masonry. Brick, block, or stone which is secured with mortar.

- Massing.* A term used to define the overall volume or size of a building.
- Modillion.* A horizontal bracket, often in the form of a plain block, ornamenting, or sometimes supporting, the underside of a cornice.
- Mortar.* A mixture of sand, lime, cement, and water used as a binding agent in masonry construction.
- Mullion.* A heavy vertical divider between windows or doors.
- Muntin.* A secondary framing member to divide and hold the panes of glass in a window.
- National Register of Historic Places.* The nation's official list of buildings, sites, and districts which are important in our history or culture. Created by Congress in 1966 and administered by the states.
- Parapet.* A low protective wall located at the edge of a roof.
- Pediment.* A triangular crowning element forming the gable of a roof; any similar triangular element used over windows, doors, etc.
- Pier.* A vertical structural element, square or rectangular in cross section.
- Pilaster.* A pier or pillar attached to a wall, often with capital and base.
- Pitch.* A term which refers to the steepness of roof slope.
- Portico.* A roofed space, open or partly enclosed, forming the entrance and centerpiece of the facade of a building, often with columns and a pediment.
- Portland cement.* A strong, inflexible (too much so for historic buildings) hydraulic cement used to bind mortar.
- Preservation.* The act of maintaining the form and character of a building as it presently exists.
- Quoins.* Decorative blocks of stone or wood used on the corners of buildings.
- Rafter.* A wooden member of a roof frame which slopes downward from the ridge line.
- Recessed panel.* A decorative element that often functions as an area for signage.
- Reconstruction.* The accurate recreation of a vanished, or irreplaceably damaged structure, or part thereof.
- Repointing.* Raking out deteriorated masonry joints and filling them with a surface mortar to repair the joint.
- Rustication.* A term applied to masonry in which the edges of the joints are chamfered or recessed.
- Sash.* The portion of a window that holds the glass and which moves.
- Sandblasting.* An abrasive cleaning method where high-powered jets of sand are directed against a surface, often the cause of the protective fire-skin of bricks.
- Scale.* A term used to define the proportions of a building in relation to its surroundings.
- SDLs.* "Simulated Divided Lights" refers to window sashes which have simulated muntins on the interior and exterior of single panes of glass. Though constructed differently, they nonetheless replicate the appearance of historic windows. See also ADLs and grilles.
- Setback.* A term used to define the distance a building is located from a street or sidewalk.

Shed roof. A gently-pitched, almost flat roof with only one slope.

Sidelight. A glass window pane located at the side of a main entrance way.

Siding. The exterior wall covering or sheathing of a structure.

Sill. The horizontal member located at the top of a foundation supporting the structure above. Also the horizontal member at the bottom of a window or door.

Spall. To split off from the surface, as brick that is bearing undue pressure near its face or is acted on by weathering.

Storefront. The street-level facade of a commercial building, usually having display windows.

Stretcher. A brick laid with the long side exposed, as opposed to a header.

Streetscape. The combination of building facades, sidewalks, street furniture, etc. that define the street.

Structural Glass. Used predominately for wall surfacing, these now familiar products included glass building blocks, reinforced plate glass, and pigmented structural glass. Pigmented structural glass, popularly known under such trade names as Carrara Glass, Sani Onyx (or Rox), and Vitrolite.

Stucco. Any kind of plasterwork, but usually an outside covering or portland cement, lime, and sand mixture with water.

Surround. An encircling border or decorative frame, usually around a window or door.

Terra Cotta. A fine-grained clay product used ornamentally to create architectural details on the exterior of buildings.

Transom. A small operable or fixed window located above a window or door.

Veranda. A covered porch or balcony on a building's exterior.

Wrought iron. Decorative iron that is hammered or forged into shape by hand.

guidelines

APPENDIX

reference

preservation briefs

The first *Preservation Brief* was published by the National Park Service in 1975. Since then, over 40 more have been added to the series. Below are the most pertinent to downtown Harlem. The *Briefs* are available on line at: <http://www2.cr.nps.gov/tps/briefs/presbhom.htm>. Printed copies can be ordered by calling 866-512-1800.

- #1 - The Cleaning & Waterproof Coating of Masonry Buildings
- #2 - Repointing Mortar Joints in Historic Masonry Buildings
- #3 - Conserving Energy in Historic Buildings
- #4 - Roofing for Historic Buildings
- #6 - Dangers of Abrasive Cleaning to Historic Buildings
- #8 - Aluminum & Vinyl Siding on Historic Buildings
- #9 - The Repair of Historic Wooden Windows
- #10 - Exterior Paint Problems on Historic Woodwork
- #11 - Rehabilitating Historic Storefronts
- #13 - The Repair & Thermal Upgrading of Historic Steel Windows
- #14 - New Exterior Additions to Historic Buildings: Preservation Concerns
- #15 - Preservation of Historic Concrete: Problems and General Approaches
- #16 - The Use of Substitute Materials on Historic Building Exteriors
- #17 - Architectural Character -Identifying the Visual Aspects of Historic Buildings as an Aid to Preserving Their Character
- #21- Repairing Historic Flat Plaster — Walls and Ceilings
- #22 - The Preservation and Repair of Historic Stucco
- #24 - Heating, Ventilating, and Cooling Historic Buildings: Problems and Recommended Approaches
- #25 - The Preservation of Historic Signs
- #27 - The Maintenance and Repair of Architectural Cast Iron
- #32 - Making Historic Properties Accessible
- #35 - Understanding Old Buildings: The Process of Architectural Investigation
- #38 - Removing Graffiti from Historic Masonry
- #39 - Managing Moisture Problems in Historic Buildings